



RoHS Compliant



# J115F1

E197852

31.7 x 26.9 x 20.3 mm

## Features

- UL F class rated standard
- Small size and light weight, low coil power consumption
- Heavy contact load, strong shock and vibration resistance
- UL/CUL, TÜV certified

## Contact Data\*

UL Contact Rating	N.O.	5A @ 280VAC Ballast
		5A @ 280VAC General Purpose
		20A @ 240VAC Resistive, 250k cycles, 40C
		25A @ 277VAC, Resistive 100k cycles, 40C
		40A @ 240VAC Resistive, 40C
	N.C.	30A @ 277VAC General Purpose
		2hp @ 250VAC, 40C; 1hp @ 125VAC, 50K cycles, 40C
		5A @ 280VAC Ballast
		5A @ 280VAC General Purpose
		30A @ 240VAC Resistive, 40C
	30A @ 30VDC, 40C	
	20A @ 277VAC General Purpose	
	1-1/2hp @ 250VAC; 1/4hp @ 125VAC 50K cycles, 40C	

TÜV Contact Rating N.O.	40A @ 240VAC; 14VDC
	30A @ 277VAC
	N.C. 30A @ 240VAC; 14VDC
	20A @ 277VAC

Contact Arrangement	1A = SPST N.O. 1B = SPST N.C. 1C = SPDT
Contact Resistance	< 30 milliohms initial
Contact Material	AgSnO <sub>2</sub> AgSnO <sub>2</sub> In <sub>2</sub> O <sub>3</sub>
Maximum Switching Power	9600VA, 1120 W
Maximum Switching Voltage	277VAC, 110VDC
Maximum Switching Current	40A

## Coil Data DC Parameters\*

Coil Voltage VDC		Coil Resistance Ω +/- 10%		Pick Up Voltage VDC (max)	Release Voltage VDC (min)	Coil Power W	Operate Time ms	Release Time ms
Rated	Max	.6W	.9W	75% of rated voltage	10% of rated voltage			
5	6.5	42	28	3.75	.5	.60 .90	15	10
9	11.7	135	90	6.75	.9			
12	15.6	240	160	9.00	1.2			
24	31.2	960	640	18.00	2.4			
48	62.4	3840	2560	36.00	4.8			
110	140.3	20167	13445	82.50	11.0			

## Coil Data AC Parameters\*

Coil Voltage VAC		Coil Resistance Ω +/- 10%		Pick Up Voltage VAC (max)	Release Voltage VAC (min)	Coil Power VA	Operate Time ms	Release Time ms
Rated	Max			75% of rated voltage	30% of rated voltage			
12	15.6		27	9.00	3.6	2VA	15	10
24	31.2		120	18.00	7.2			
110	143		2360	82.50	33.0			
120	156		3040	90.00	36.0			
220	286		13490	165.00	66.0			
240	312		15320	180.00	72.0			
277	360		20210	207.00	83.1			

# J115F1

## General Data\*

Electrical Life @ rated load	100K cycles, average
Mechanical Life	10M cycles, average
Insulation Resistance	1000M $\Omega$ min. @ 500VDC initial
Dielectric Strength	Coil to Contact
	Contact to Contact
	4000V rms min. @ sea level initial (H = high dielectric strength option) 2500V rms min. @ sea level initial (with Pin 6 removed) 1500V rms min. @ sea level initial
Shock Resistance	200m/s <sup>2</sup> for 11 ms
Vibration Resistance	1.50mm double amplitude 10~40Hz
Terminal (Copper Alloy) Strength	10N
Operating Temperature	-55°C to +125°C
Storage Temperature	-55°C to +155°C
Solderability	260°C for 5 s
Weight	30g, 27g (no cover)

\* Values can change due to the switching frequency, desired reliability levels, environmental conditions and in-rush load levels. It is recommended to test actual load conditions for the application. It is the user's responsibility to determine the performance suitability for their specific application. The use of any coil voltage less than the rated coil voltage may compromise the operation of the relay.

## Ordering Information

1. Series	J115F1	1C	12VDC	S	6	.6
J115F1						
2. Contact Arrangement	1A = SPST N.O. 1B = SPST N.C. 1C = SPDT					
3. Coil Voltage	5VDC      12VAC 9VDC      24VAC 12VDC     110VAC 24VDC     120VAC 48VDC     220VAC 110VDC    240VAC 277VAC					
4. Sealing Options	S = Sealed (standard) N = No cover					
5. Option	None = Pin 6 included **not available with AC coils 6 = Pin 6 removed H = Pin 6 removed & high dielectric strength resistant **not available with AC coils					
6. Coil Power	.9 = .9W .6 = .6W Blank = 2VA (AC Coil)					
7. Contact Material	Blank = AgSnO <sub>2</sub> U = AgSnO <sub>2</sub> In <sub>2</sub> O <sub>3</sub>					

# J115F1

## Dimensions

Units = mm

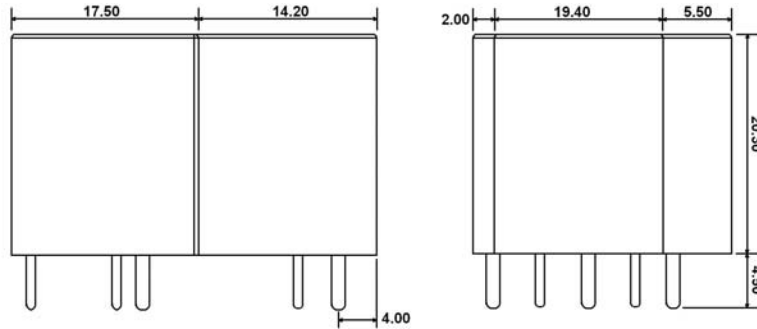

**S = Sealed**

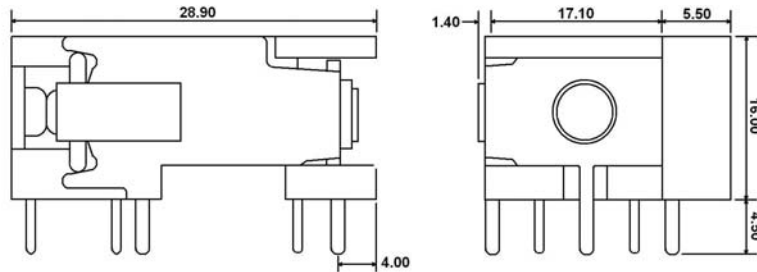

**N = No Cover**

## Schematics & PC Layouts

Bottom Views

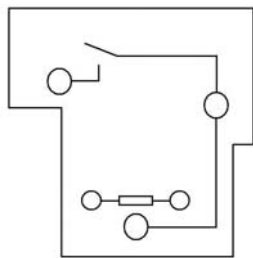

**1A**

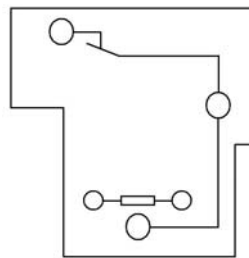

**1B**

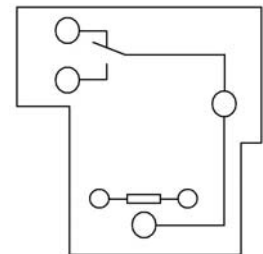

**1C**

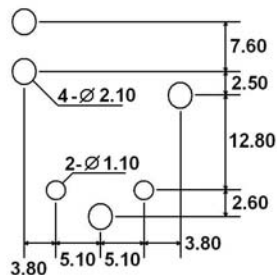

**With Pin 6**

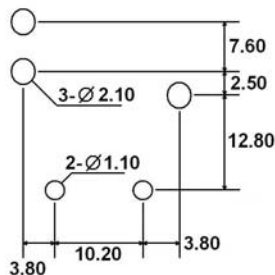

**Without Pin 6**