

"18650" LITHIUM-ION BATTERY HOLDERS

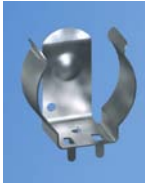

NOTE: PC Mount Battery Clip Available See Page 9.

"18650" CELL

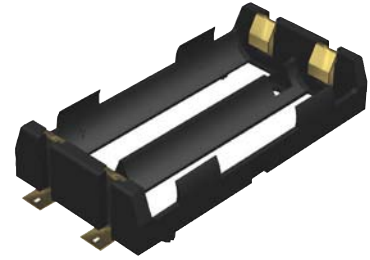

FEATURES

- Low profile surface mount holder for Cylindrical Lithium and alkaline batteries
- UL 94V-0 heat resistant nylon housing well suited for reflow soldering
- Battery installation and removal does not require tools

- Securely holds battery in place
- Polarity clearly marked for orientation
- Accommodates cells with or without built-in PCB protection circuits

Operating Temp Range:
-60°F to +290°F (-50°C to +145°C)

APPLICATIONS

- Computer memory, power backup systems
- Digital readers
- Laptop and touch pad computers
- PLC and industrial controls

THRU HOLE MOUNT

SINGLE CELL

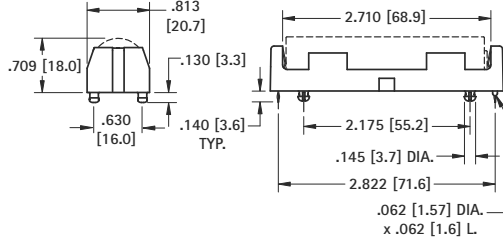

Mounting Detail

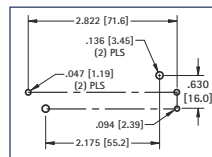

SPECIFICATIONS

Base: High Temp Nylon 46, UL 94V-0
Contacts: .012 (.30) Phosphor Bronze, Tin-Nickel Plate

CAT. NO. 1043

SURFACE MOUNT

SINGLE CELL

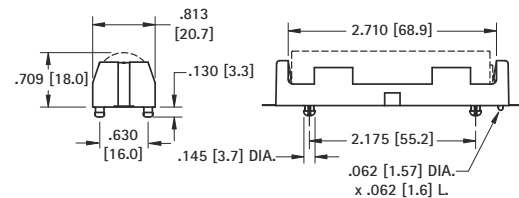

Pad Layout

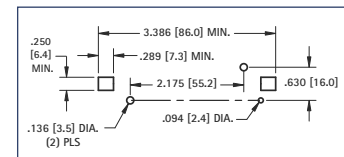

SPECIFICATIONS

Base: High Temp Nylon 46, UL 94V-0
Contacts: .012 (.30) Phosphor Bronze, Gold Plate (Flash)

CAT. NO. 1042

DUAL CELL

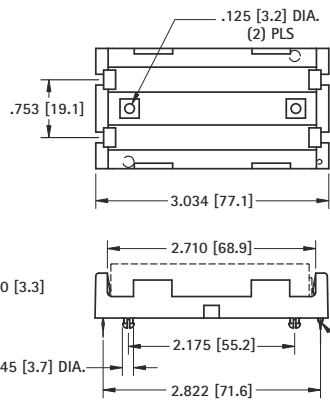

Mounting Detail

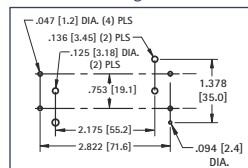

SPECIFICATIONS

Base: High Temp Nylon 46, UL 94V-0
Contacts: .012 (.30) Phosphor Bronze, Tin-Nickel Plate

CAT. NO. 1049

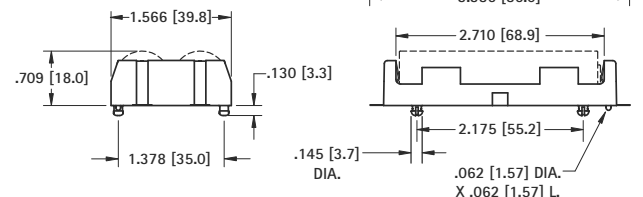

Pad Layout

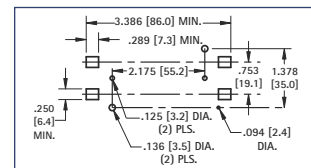

SPECIFICATIONS

Base: High Temp Nylon 46, UL 94V-0
Contacts: .012 (.30) Phosphor Bronze, Gold Plate (Flash)

CAT. NO. 1048