

Features

- Ideal for indication light on hand held products
- Long life and robust package
- Standard Package: 4,000pcs/ Reel
- MSL (Moisture Sensitivity Level): 2
- Low current $I_F=5\text{mA}$ operating.
- RoHS compliant



ATTENTION
OBSERVE PRECAUTIONS
FOR HANDLING
ELECTROSTATIC
DISCHARGE
SENSITIVE
DEVICES

Package Schematics

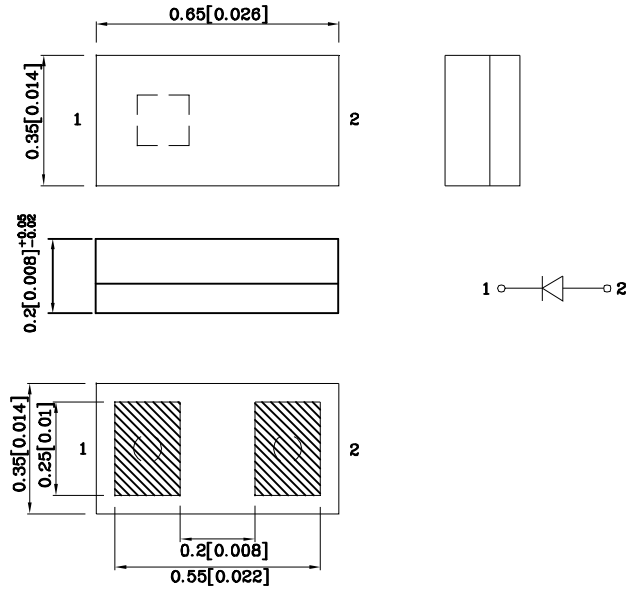

Notes:

1. All dimensions are in millimeters (inches).
2. Tolerance is $\pm 0.1(0.004)$ unless otherwise noted.
3. Specifications are subject to change without notice.

Absolute Maximum Ratings ($T_A=25^\circ\text{C}$)		White (InGaN)	Unit
Reverse Voltage	V_R	5	V
Forward Current	I_F	10	mA
Forward Current (Peak) 1/10 Duty Cycle 0.1ms Pulse Width	i_{FS}	50	mA
Power Dissipation	P_D	32	mW
Electrostatic Discharge Threshold (HBM)		1000	V
Operating Temperature	T_A	-40 ~ +85	°C
Storage Temperature	T_{stg}	-40 ~ +85	

A Relative Humidity between 40% and 60% is recommended in ESD-protected work areas to reduce static build up during assembly process (Reference JEDEC/JESD625-A and JEDEC/J-STD-033)

Operating Characteristics ($T_A=25^\circ\text{C}$)		White (InGaN)	Unit
Forward Voltage (Typ.) ($I_F=5\text{mA}$)	V_F	2.9	V
Forward Voltage (Max.) ($I_F=5\text{mA}$)	V_F	3.1	V
Reverse Current (Max.) ($V_R=5\text{V}$)	I_R	50	μA
Chromaticity Coordinates (Typ.)	x	0.31	
	y	0.31	

Part Number	Emitting Color	Emitting Material	Lens-color	Luminous Intensity CIE127-2007* ($I_F=5\text{mA}$) mcd		Viewing Angle 20 1/2
				min.	typ.	
XZBWR155F5MAV	White	InGaN	Yellow Fluorescent	30*	98*	135°

*Luminous Intensity value is in accordance with CIE127-2007 standards.

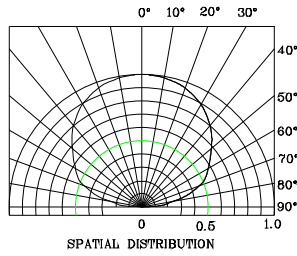

❖ White

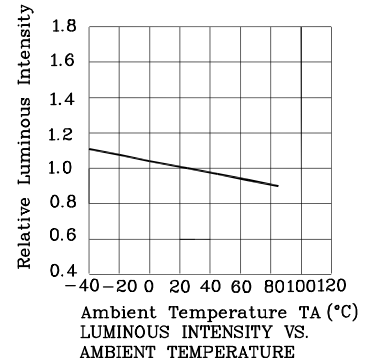
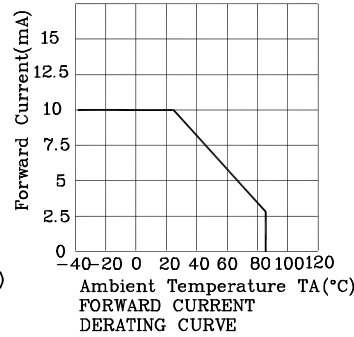
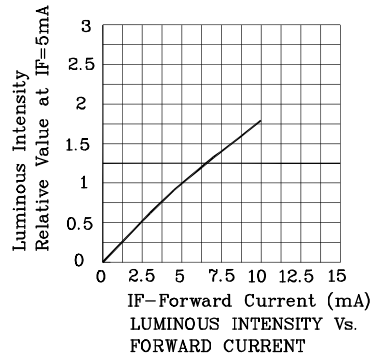
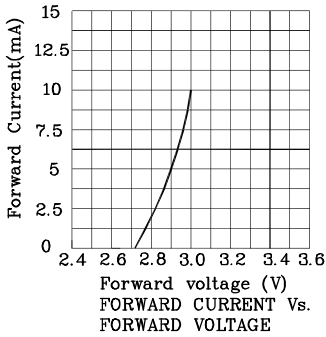

LED is recommended for reflow soldering and soldering profile is shown below.

Reflow Soldering Profile for SMD Products (Pb-Free Components)

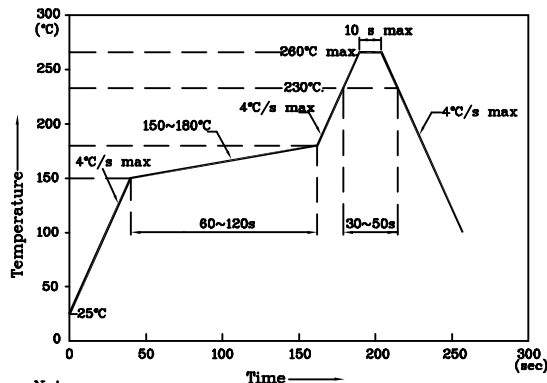

Notes:

1. Maximum soldering temperature should not exceed 260°C
2. Recommended reflow temperature: 145°C-260°C
3. Do not put stress to the epoxy resin during high temperatures conditions



XZBWR155F5MAV

White CIE

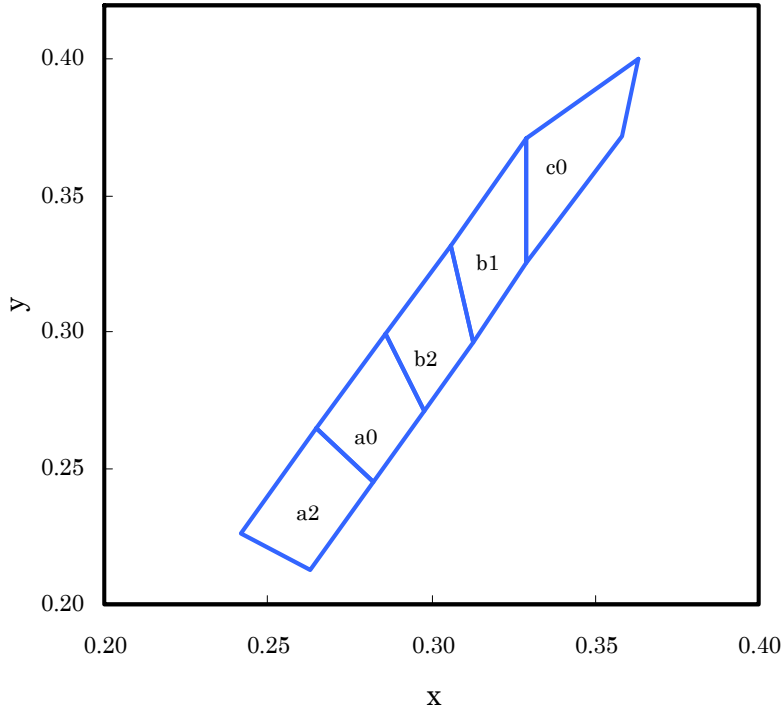

	x	y		x	y		x	y
a2	0.263	0.213	a0	0.282	0.245	b2	0.298	0.271
	0.282	0.245		0.298	0.271		0.313	0.296
	0.265	0.265		0.286	0.299		0.306	0.332
	0.242	0.226		0.265	0.265		0.286	0.299
b1	0.313	0.296	c0	0.329	0.325			
	0.329	0.325		0.358	0.372			
	0.329	0.371		0.363	0.400			
	0.306	0.332		0.329	0.371			

Notes:

Shipment may contain more than one chromaticity regions.
Orders for single chromaticity region are generally not accepted.
Measurement tolerance of the chromaticity coordinates is ± 0.01 .



❖ The device has a single mounting surface.
The device must be mounted according to
the specifications.

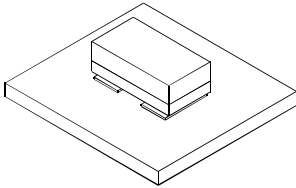

❖ Recommended Soldering Pattern
(Units : mm; Tolerance: ± 0.1)

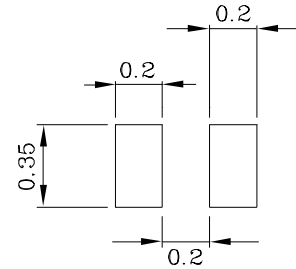

❖ Reel Dimension

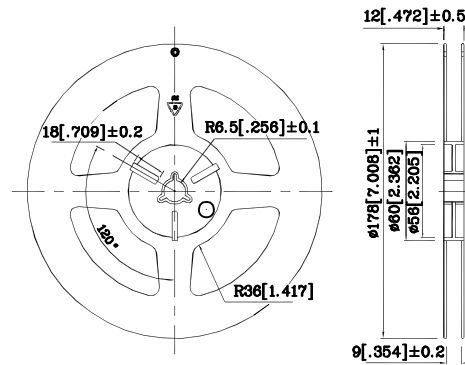

❖ Tape Specification (Units : mm)

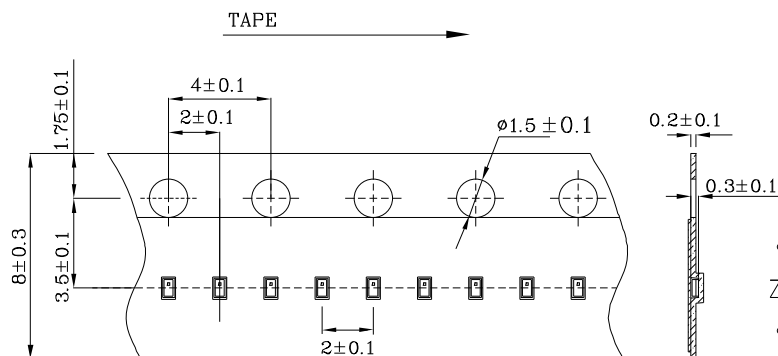



Remarks:



If special sorting is required (e.g. binning based on forward voltage, Luminous intensity / luminous flux, or chromaticity), the typical accuracy of the sorting process is as follows:

1. Measurement tolerance of the chromaticity coordinates is ± 0.01 .
2. Luminous intensity / Luminous Flux: $\pm 15\%$
3. Forward Voltage: $\pm 0.1V$

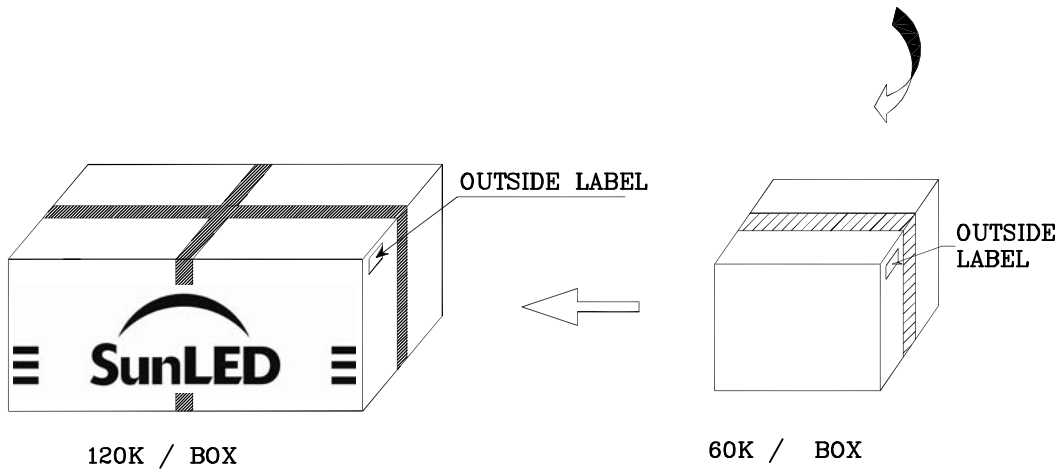
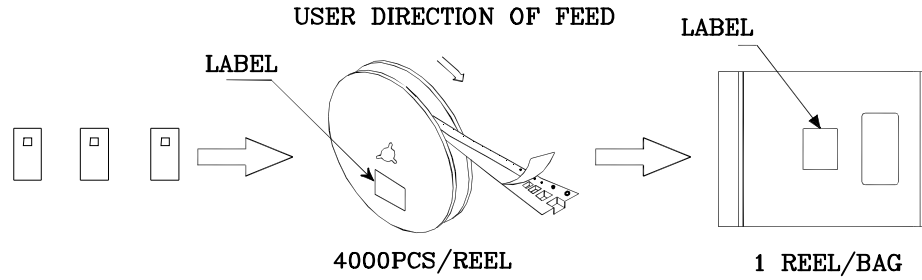
Note: Accuracy may depend on the sorting parameters.

PACKING & LABEL SPECIFICATIONS

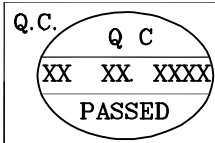
	
P/NO : XZxxx155x	
QTY : 4,000 pcs	CODE: XXX
S/N : XX	
LOT NO:	
 XXXXXXXXXXXXXXXXXXXXXXXX	
RoHS Compliant	

TERMS OF USE

1. Data presented in this document reflect statistical figures and should be treated as technical reference only.
2. Contents within this document are subject to improvement and enhancement changes without notice.
3. The product(s) in this document are designed to be operated within the electrical and environmental specifications indicated on the datasheet. User accepts full risk and responsibility when operating the product(s) beyond their intended specifications.
4. The product(s) described in this document are intended for electronic applications in which a person's life is not reliant upon the LED. Please consult with a SunLED representative for special applications where the LED may have a direct impact on a person's life.
5. The contents within this document may not be altered without prior consent by SunLED.
6. Additional technical notes are available at <http://www.SunLEDusa.com/TechnicalNotes.asp>