



# EJOT®

## **EJOT FDS®**

The self piercing and  
extruding screw for  
high-strength sheet joints



**EJOT® The Quality Connection**

---

## Contents

3	.....	The product
5	.....	Operational characteristics
6	.....	Designs
10	.....	Design recommendations
12	.....	Assembly recommendations
14	.....	Properties in use
16	.....	Application engineering
18	.....	EJOT – Your system partner

### Your contact:

[www.ejot.com](http://www.ejot.com)

---

### Imprint

#### Editor:

EJOT GmbH & Co. KG  
Industrial Fasteners Division  
D-57334 Bad Laasphe

#### Layout und Realisation:

EJOT GmbH & Co. KG  
Industrial Fasteners Division  
D-57334 Bad Laasphe

#### Print:

Druckerei  
D-

© by EJOT GmbH & Co. KG

EJOT®, FDS®, ALtracs® and EJOMAT® are registered trademarks of EJOT GmbH & Co. KG.

TORX®, TORX PLUS® and AUTOSERT® are registered trademarks of Camcar, Div. of Textron, Rockford IL.

All technical data may be subject to technical improvements.

## Convincing facts about the EJOT FDS® joint

EJOT FDS®

The product

- removable and highstrength screw joint, without part preparations like punching or drilling
- no problems regarding hole overlapping of clearance and pilot hole
- no material waste while forming the through draught / no chips during thread forming
- several metric threads are engaged
- safety margine concerning a large distance between installation and stripping torque
- high shearing strength and pull-out force
- assembly in different sheet surfaces is possible
- high break loose torque and vibration resistance
- repeat assemblies also possible by using standard maschine screws (ordinary)
- earthing assemblies (e.g. to DIN VDE 0700 or UL) are practical
- easy to disassemble and recyclable
- low overall joint costs

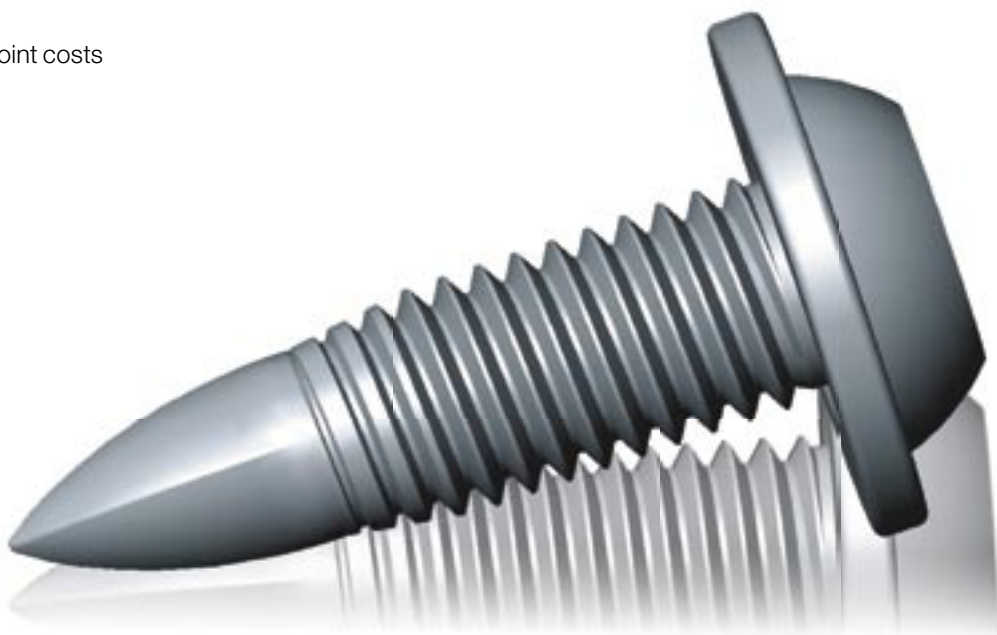

**The product**



*example in practice: white-good industry*



*example in practice: automotive industry*

**Secure screw joints for steel and aluminium sheets**

Steel is still the most dominating material for designs within the sheet metal industry due to its advantageous characteristics in terms of processing and application. But steel is increasingly in competition to specific lighter materials i.e. aluminium. Knowing this, the steel industry has developed a number of new steel sheet materials in recent years, which are showing higher strength by equal good deformation qualities. Besides the common cold-rolled soft steels DC01-DC06 (according DIN EN 10130) as the typical steel for deep-drawing, micro alloyed thin sheets with higher yield strength H240M (ZStE 260) – H400M (ZStE 420) according DIN EN 10268 (SEW093) and Dual-Phase steels type DP according SEW 097 part 2 are worth mentioning. Both materials play a significant roll in the field of high strength steel sheet assemblies.

In the automotive industry, not hardenable AlMg and AlMgMn alloys from the 5000er group and thermic hardenable AlMgSi alloys from the 6000er group, in strength grade T4 up to T6, are being used mainly - grades T4 / T5 for sheet materials and grade T6 preferably for extrusions.

The maximum exploitation of the respective properties for those steel and aluminium materials requires often reconsidering of the common assembly technique, in particular by joining together different materials.

The flow drilling EJOT FDS® Screw opens up new possibilities for high strength screw joints; due to the increase of thread engagement in the formed trough draught.

The female metric thread, formed without chips during insertion process, is to DIN and therefore enables a standard machine screw being used for repair purposes.

Due to the backlash-free thread engagement of several metric threads, the screw joint is waterproof and gastight and withstands also high pull out and shear forces. The created heat during the through draught forming process is below the needed temperature for the recrystallization of assembly materials and therefore harmless. The FDS® assembly is regarded as a heat poor assembly method. Due to the remaining temperature in the joint after the initial assembly, shrinking of the through draught onto the screw thread takes place. High dynamic safety of the screw joint is achieved with this effect.

Therefore additional safety elements like locking patches can be eliminated.

Due to the lack of component preparation like drilling or punching, known tolerance issues and lining up of clearance holes are things of the past. The possibility of one sided assembly with FDS® makes an installation into hollow profiles or extrusions possible without holding-up.

Operational characteristics

**Stages of the FDS® assembly**

1. Warming up the sheet metal by end load and high speed
2. Penetration into the material
3. Forming of the through draught
4. Chipless forming of female machine thread
5. Engagement of full threads
6. Tightening with the pre-set torque

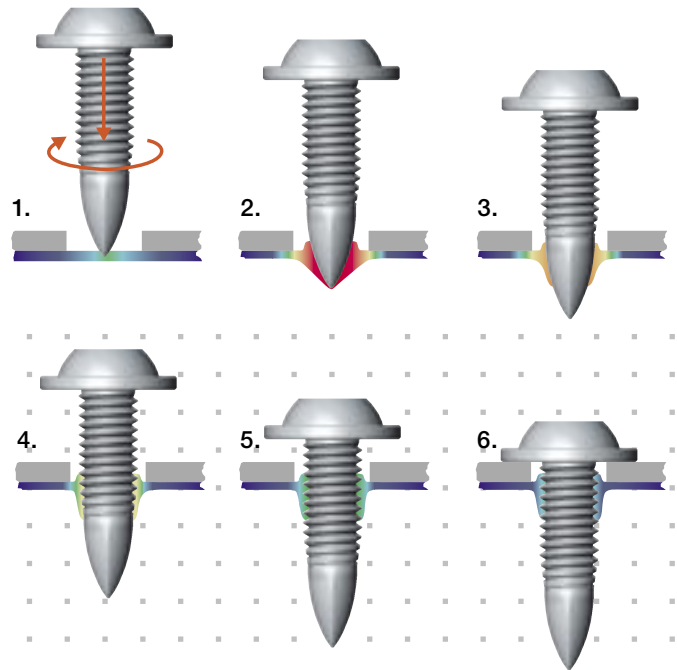

**Temperature pictures of a FDS® joint**

1. Heating
2. Penetrating
3. Through draught forming
4. Thread forming
5. Engagement of full threads
6. Tightening

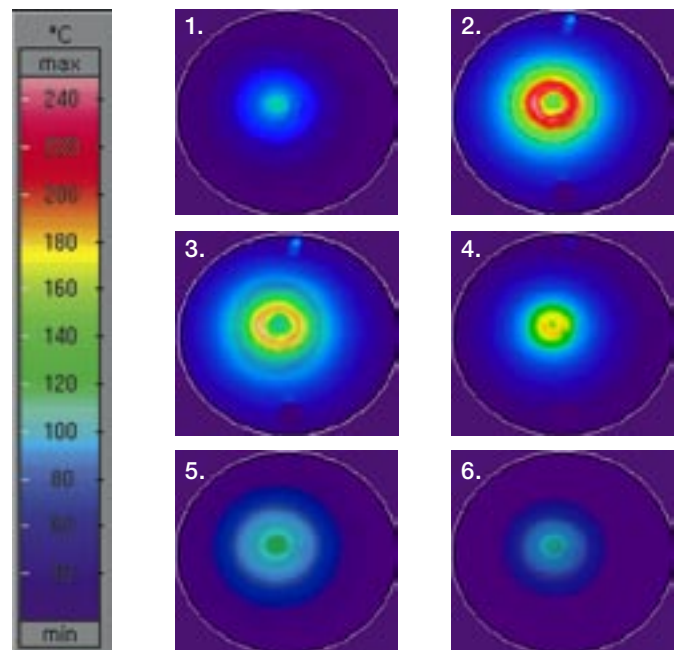

**Fastening parameter**

Material: 0,8 mm steel plate  
DC 04 (without pilot hole)

Screw: EJOT FDS® M 3,5

Driver speed: 2300 rpm

Due to the multipurpose application structure of sheet assemblies, several types of the EJOT FDS® fastener have been developed.

The type Standard is usually preferred for full automatic assembly without pilot hole.

For simple manual assembly a pilot hole in combination with the type PKS is useful.

For manual assembly without a pilot hole, the type BS is recommended. Only in this case please consider the swarf (chips) during the drilling process.

Concerning the types PKS and BS the process of prepunching respectively drilling facilitates the penetration into the sheet metal. The necessary end load for the assembly can be reduced by about 50 %. As the diameter of the pilot hole or of the drill point is smaller than the core diameter of the screw, a through draught is formed of the remaining sheet metal as well.

The bottom diagram on page 11 shows corresponding diameters for prepunched holes.

**End load as a function of the screw point type and prepunching at constant assembly times**

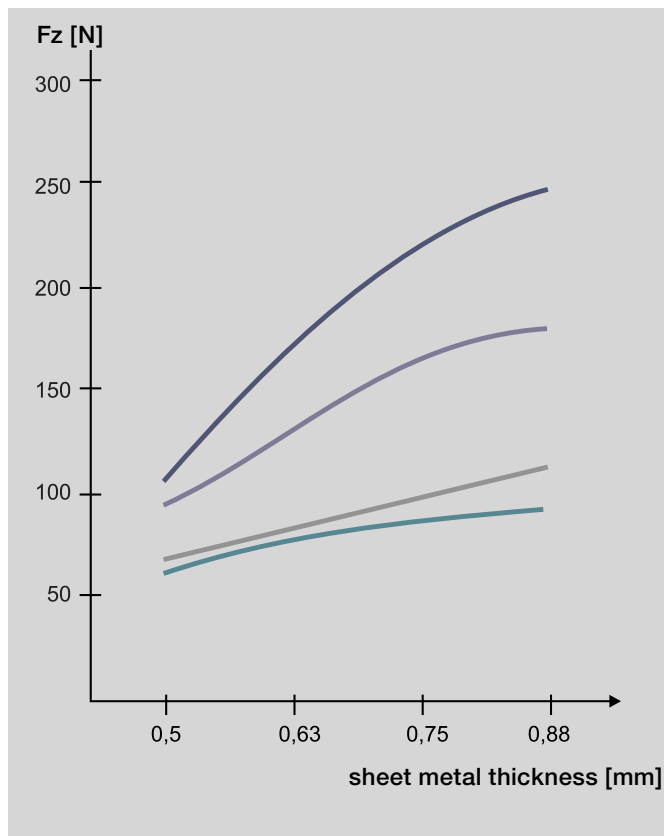

- type standard without prepunching
- type standard with punch mark 60°
- type PKS with prepunching  
 at 0,50 mm sheet metal thickness Ø 2,2 mm  
 at 0,63 mm sheet metal thickness Ø 2,4 mm  
 at 0,75 mm sheet metal thickness Ø 2,6 mm  
 at 0,88 mm sheet metal thickness Ø 2,8 mm
- type BS with drill point Ø 2,4 mm

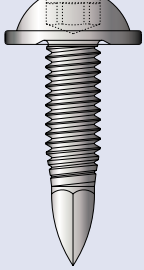
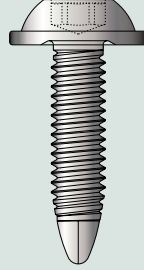
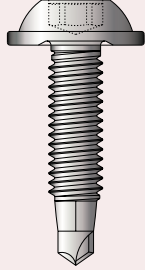

Type	Standard	PKS	BS
			
<b>Screw material</b>	case hardened mild steel	case hardened mild steel, stainless steel	case hardened mild steel
<b>Surfaces</b>	<p><b>Chrom VI-free surfaces:</b>  zinc clear / blue passivated  zinc clear / blue passivated + EJOSEAL (240h resistance to Zn-corrosion)  ZnFe or ZnNi, transparent passivated (with or without black top coats)  zinc flake coatings (with or without black top coats)  ZnNi / black passivated</p> <p><b>Different plating upon request!</b></p>		
<b>Application</b>	fastening without prepunching	fastening with prepunching	fastening without prepunching
<b>Installation material</b>	steel            0,3 - 2,0 mm aluminium    0,3 - 3,5 mm magnesium    1,0 - 3,5 mm	steel            0,4 - 2,0 mm aluminium    0,4 - 3,0 mm magnesium    1,0 - 3,5 mm stainless steel 0,4 - 1,5 mm	steel            0,4 - 2,0 mm aluminium    0,4 - 3,0 mm magnesium    1,0 - 3,5 mm
<b>Characteristics</b>	fastening without prepunching  tolerance-free assembly, because of no misalignment with clearance hole  suited especially for automated assembly  extremely high joint strength  onesided assembly  ideal screw for safe assembly and dynamic loads  the through draught is about 3 times as high as the original sheet metal thickness	pilot hole diameter about half the nominal screw diameter  due to the bigger clearance hole compare to the smaller pilot hole, some tolerances can be compensated (S. 11)  preferable for manual assembly  low end load  onesided assembly  despite the pilot hole there is high process safety and joint strength  the through draught is about twice as high as the original sheet metal thickness	fixing into unpunched sheet metals  tolerance-free assembly, because of no misalignment with clearance hole  suited for automated and manual assembly  low end load  onesided assembly  high joint strength  the through draught is about twice as high as the original sheet metal thickness

**WN 2141**

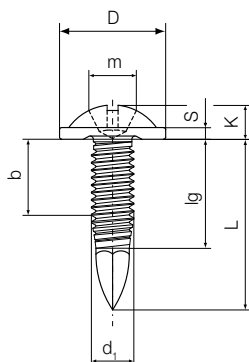

**WN 2142**

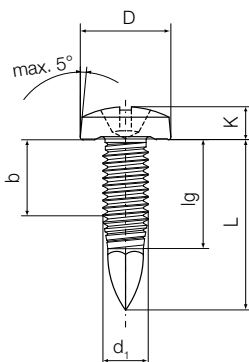

**WN 2143**

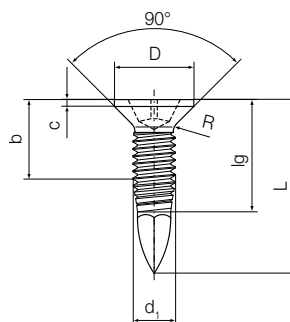

**WN 2147**

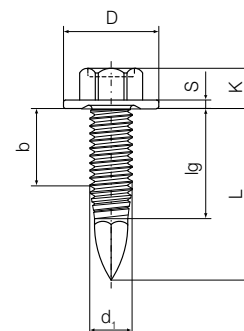

**H-cross recess**

**Z-cross recess**

**TORX®**

**TORXplus® /  
AUTOSERT®**



In case of manual assembly with TORX® it is recommended to use a TORXALIGN® bit, e.g. STICK FIT bits by TORX PLUS® drives.

All cross recess and TORX® drives are also available as combi drives.

EJOT FDS®	Nominal-Ø		M 3	M 3,5	M 4	M 5	M 6
	External thread-Ø	d <sub>1</sub>	3,0	3,5	4,0	5,0	6,0

WN 2141	Head-Ø	D							
			7,50	8,50	10,00	12,00	14,00		
	Head height	K	2,40	2,50	3,20	4,00	4,60		
	Washer thickness	s	0,80	0,90	1,10	1,30	1,50		
	H-cross-recess	penetration depth	t	min.	1,07	1,33	1,98	2,24	2,84
				max.	1,70	1,96	2,61	2,90	3,50
	Z-cross-recess	penetration depth	t	min.	1,08	1,40	2,01	2,27	2,91
				max.	1,54	1,86	2,47	2,73	3,37
	Cross size H/Z		1	2	2	3	3		

WN 2142	Head-Ø	D							
			6,00	7,00	8,00	10,00	12,00		
	Head height	K	2,40	2,70	3,10	3,80	4,60		
	H-cross-recess	penetration depth	t	min.	1,70	1,74	2,04	2,77	3,03
				max.	2,00	2,24	2,54	3,27	3,53
	Z-cross-recess	penetration depth	t	min.	1,68	1,65	1,90	2,64	3,02
				max.	1,93	2,11	2,36	3,10	3,48
	Cross size H/Z		1	2	2	2	3		

WN 2143	Head-Ø	D							
			5,60	6,50	7,50	9,20	11,00		
	Cyl. head height	c <sub>max</sub>	0,55	0,55	0,65	0,75	0,85		
	Radius	R <sub>max</sub>	0,80	0,95	1,00	1,30	1,60		
	H-cross-recess	penetration depth	t	min.	1,50	1,40	1,90	2,10	2,80
				max.	1,80	1,90	2,40	2,60	3,30
	Z-cross-recess	penetration depth	t	min.	1,48	1,34	1,60	2,05	2,46
				max.	1,73	1,80	2,06	2,51	2,92
	Cross size H/Z		1	2	2	2	3		

WN 2147	Washer-Ø	D	7,50	8,30	9,00	11,00	13,00
	Head height	K	3,00	3,40	3,80	4,30	5,00
	Washer thickness	s	0,60	0,80	0,80	1,00	1,20
	Width across flats	SW	5,00	5,50	5,50	7,00	8,00



**WN 2151**

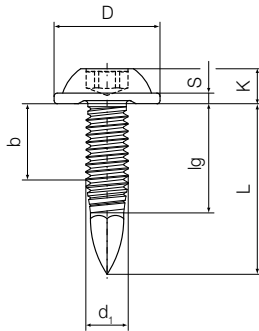

**WN 2152**

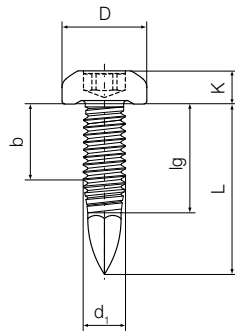

**WN 2153**

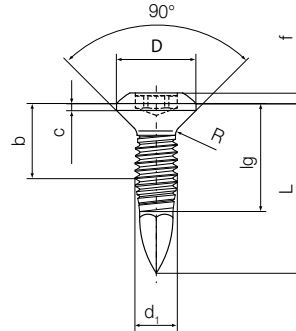

**ambit**

All WN-specifications according to types:

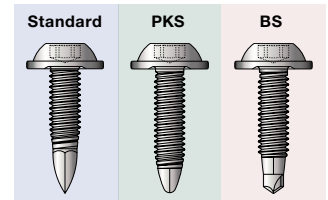

**Example of ordering:**

Description of EJOT FDS® screw Ø 4 mm and length 20 mm

- a) type Standard with Z-cross recess according to WN 2141:
- b) type PKS with TORX® recess according to WN 2152:
- c) type BS with hexagonal head according to WN 2147:

**EJOT FDS® screw M4 x 20 WN2141-Z**

**EJOT FDS® screw M4 x 20 PKS WN2152**

**EJOT FDS® screw M4 x 20 BS WN2147**

EJOT FDS®	Nominal-Ø		M 3	M 3,5	M 4	M 5	M 6
	External thread-Ø	d <sub>1</sub>	3,0	3,5	4,0	5,0	6,0

<b>WN 2151</b>	Head-Ø	D	7,50	8,50	10,00	12,00	14,00
	Head height	K	2,40	2,60	3,30	3,60	4,20
	Washer thickness	s	0,70	0,80	1,00	1,20	1,40
	<b>TORX®</b>		T10	T15	T20	T25	T30
	Penetration depth	t	A <sub>max.</sub>	2,80	3,35	3,95	4,50
min.			1,00	1,20	1,40	1,60	2,00
max.			1,30	1,50	1,80	2,00	2,40

<b>WN 2152</b>	Head-Ø	D	6,00	7,00	8,00	10,00	12,00	
	Head height	K	2,40	2,70	3,10	3,80	4,60	
	<b>TORX®</b>		T10	T15	T20	T25	T30	
	Penetration depth	t	A <sub>max.</sub>	2,80	3,35	3,95	4,50	5,60
			min.	1,00	1,20	1,40	1,60	2,00
max.			1,30	1,50	1,80	2,00	2,40	

<b>WN 2153</b>	Head-Ø	D	5,60	6,50	7,50	9,20	11,00
	» f		0,75	0,90	1,00	1,25	1,00
	Cyl. Head height	c <sub>max.</sub>	0,55	0,55	0,65	0,75	0,85
	Radius	R <sub>max.</sub>	0,80	0,95	1,00	1,30	1,60
	<b>TORX®</b>		T10	T15	T20	T25	T30
Penetration depth	t	A <sub>max.</sub>	2,80	3,35	3,95	4,50	5,60
		min.	1,00	1,20	1,40	1,60	2,00
		max.	1,30	1,50	1,80	2,00	2,40

**Special variations / Examples**

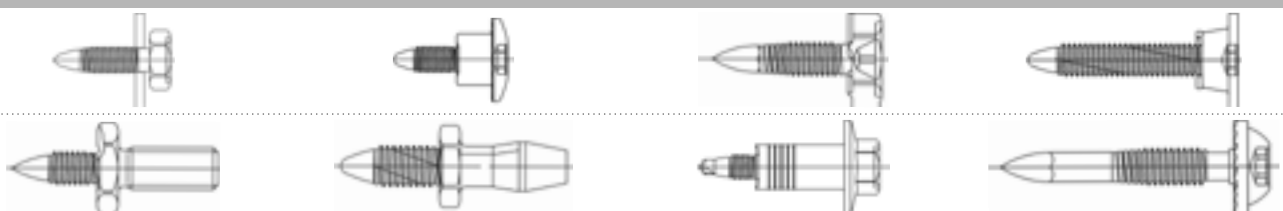

Special variations are available.

Please contact the EJOT application engineers to realize your multifunctional design.

In many applications the EJOT FDS® can be used with existing products.

The following notes are for the design of existing and new products.

The **usable thread length b** of EJOT FDS® screws is depending on the part's thickness  $S_1$  and the metal sheet thickness  $S_2$ .

It is given by:

$$b = S_1 + 3 \times S_2 \text{ without prepunching (type Standard)}$$

$$b = S_1 + 2 \times S_2 \text{ with prepunching (type PKS and BS)}$$

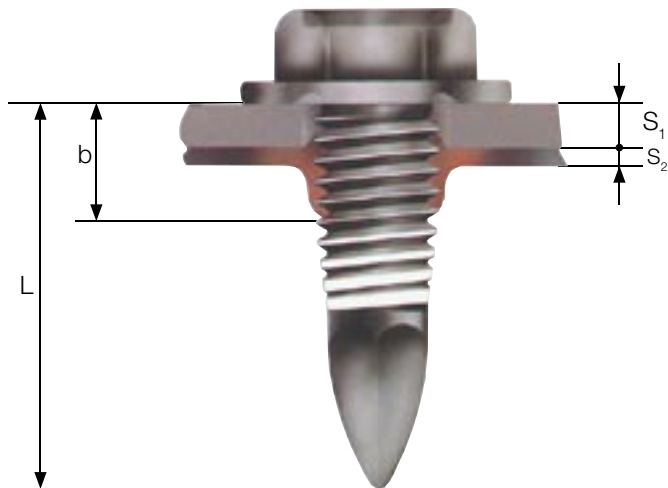

The corresponding nominal screw length L can be taken from the accompanying table below.

**Example**

$S_1 = 4,50 \text{ mm}, S_2 = 0,75 \text{ mm}:$

**without prepunching**

$$b = (4,50 + 3 \times 0,75) \text{ mm} = 6,75 \text{ mm}$$

**with prepunching**

$$b = (4,50 + 2 \times 0,75) \text{ mm} = 6,00 \text{ mm}$$

For an FDS® M5 Standard (unpunched) the accompanying table provides a usable thread length of  $b = 6,90 \text{ mm}$  according to a nominal length of  $L = 18 \text{ mm}$ .

For assembly with prepunching therefore a FDS® M5 x 14 PKS with usable thread length of  $b = 6,20 \text{ mm}$  according to a nominal length of  $L = 14 \text{ mm}$ .

**Manufacturing range**

EJOT FDS® screw	M3			M3,5			M4			M5			M6		
	Standard	PKS	BS	Standard	PKS	BS	Standard	PKS	BS	Standard	PKS	BS	Standard	PKS	BS
<b>Length L [mm]</b>	<b>Usable thread length b [mm]</b>														
9 + 0,4	2,40	4,70													
10 + 0,8	3,40	5,70		2,40	4,90	4,60									
12 + 0,8	5,40	7,70		4,40	6,90	6,60	3,10	5,70	5,40						
14 + 0,8	7,40	9,70		6,40	8,90	8,60	5,10	7,70	7,40	2,90	6,20	6,10			
16 + 0,8	9,40	11,70		8,40	10,90	10,60	7,10	9,70	9,40	4,90	8,20	8,10	2,90	6,60	5,90
18 + 0,8	11,40	13,90		10,40	12,90	12,60	9,10	11,70	11,40	6,90	10,20	10,10	4,90	8,60	7,90
20 + 0,8	13,40	15,70		12,40	14,90	14,60	11,10	13,70	13,40	8,90	12,20	12,10	6,90	10,60	9,90
25 + 0,8				17,40	19,90	19,60	16,10	18,70	18,40	13,90	17,20	17,10	11,90	15,60	14,90
30 + 0,8				22,40	24,90	24,60	21,10	23,70	23,40	18,90	22,20	22,10	16,90	20,60	19,90
35 + 1,0							26,10	28,70	28,40	23,90	27,20	27,10	21,90	25,60	24,90
40 + 1,0							31,10	33,70	33,40	28,90	32,20	32,10	26,90	30,60	29,90
45 + 1,0										33,90	37,20	37,10	31,90	35,60	34,90
50 + 1,0										38,90	42,20	42,10	36,90	40,60	39,90
55 + 1,0										43,90	47,20	47,10	41,90	45,60	44,90
60 + 1,0													46,90	50,60	49,90
70 + 1,0													56,90	60,60	59,90

Special lengths upon request.

- - - - = minimal length for WN2143 und 2153

**Design recommendations**

**Recommended clearance hole  $d_D$  [mm]**

By flowdrilling, a small portion of the formed part is flowing opposite to the fastening direction and creating a bulge that has to be accommodated by the upper part's clearance-hole. Therefore we recommend the following hole diameter.

FDS®	M3	M3,5	M4	M5	M6
$d_D$	3,6 - 4,0	4,3 - 4,8	5,1 - 5,7	6,7 - 7,4	8,2 - 9,1

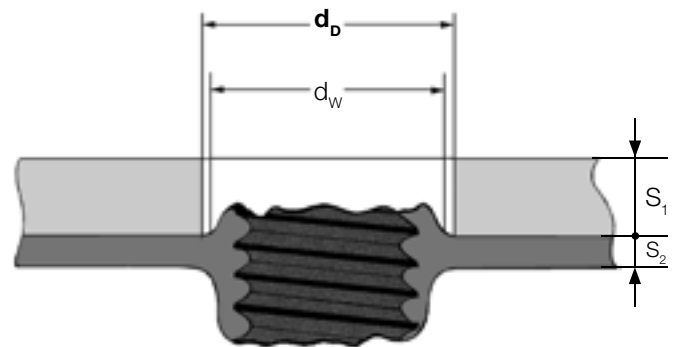

Clearance hole  $d_D$  for clamped material  
 $d_w$  : bulge diameter  
 $d_D$  : clearance hole

**Recommendation hole diameter  $d_v$  [mm] for type PKS**

The optimum hole diameter depends on the respective requirement and is stipulated in an application specific way.

FDS®	M3	M3,5	M4	M5	M6	
sheet thickness $S_2$ in mm	0,5	1,0 - 1,5	1,2 - 1,7	1,5 - 2,0	1,8 - 2,5	-
	0,63	1,2 - 1,6	1,4 - 1,8	1,5 - 2,2	1,8 - 2,5	2,0 - 3,0
	0,75	1,4 - 1,8	1,5 - 2,0	1,5 - 2,5	2,0 - 2,8	2,0 - 3,2
	0,88	1,6 - 2,0	1,6 - 2,2	1,8 - 2,5	2,0 - 3,0	2,5 - 3,5
	1,00	-	1,8 - 2,4	2,0 - 2,8	2,5 - 3,5	2,5 - 3,8
	1,25	-	2,2 - 2,6	2,2 - 2,8	2,8 - 3,8	3,0 - 4,5
	1,50	-	-	2,6 - 3,2	3,2 - 3,8	3,6 - 4,8
	1,75	-	-	-	3,4 - 4,0	3,8 - 5,0
	2,00	-	-	-	3,7 - 4,2	3,8 - 5,0

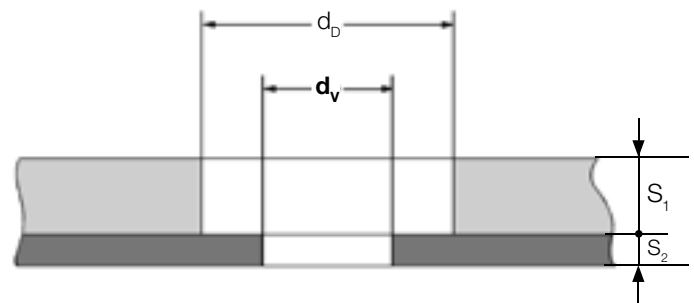

Pilot hole  $d_v$  for the installation part (type PKS)

$d_v$  : pilot hole diameter  
 $d_D$  : clearance hole

**Note for manual assembly**

For manual assembly into sheet metal thicker than: steel > 0,80 mm; Aluminium > 1,25 mm a higher end load is necessary. As a result we recommend the use of either a pilot hole or our FDS® type BS.

Another possibility is employing the use of a pneumatic end load initiated drive tool, which allows a manual assembly in sheet metal thicknesses up to 1,50 mm (steel) and 2,00 mm (aluminium) without installation part preparation.

When fastening into sheet metal steel > 2,0 mm we recommended the use of the EJOT Spiralform® screws or EJOT drill screws, for aluminium > 3,5 mm the use of the EJOT ALtracs® screws.

**For more informations about the design and design or assembly recommendations please contact:**

phone +49 2752 109-123  
 fax +49 2752 109-268  
 e-mail: hotline@ejot.de

**Assembly recommendations**

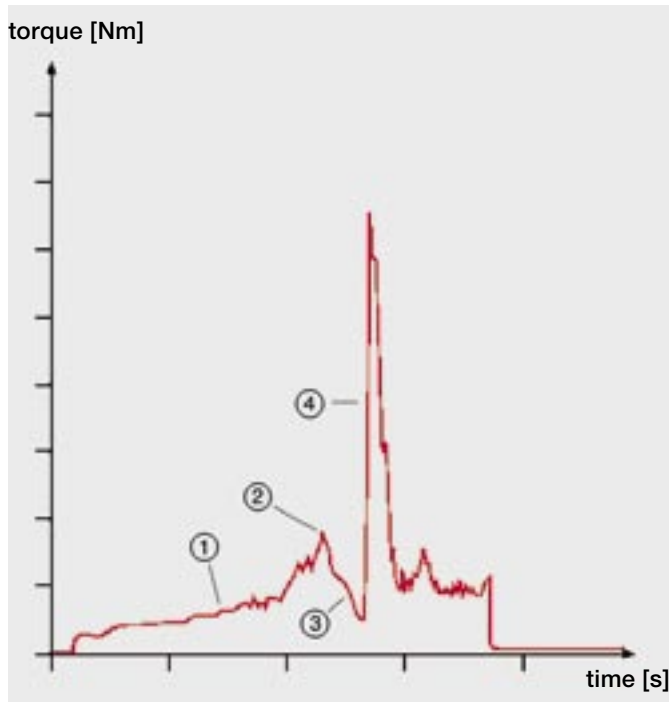

**Fastening**

During the fastening process the following graph of the installation torque can be observed over time.

- ① Through draught forming
- ② Thread forming
- ③ Engagements of full threads
- ④ Tightening

The fastening time which is necessary for EJOT FDS® mainly depends upon the flowdrilling process.

Parameters are:

- Screw diameter
- Type of screw point
- driver tool speed
- sheet thickness
- sheet quality / material specification
- end load
- part preparation yes / no

Corresponding data for your application purpose will be established for you.

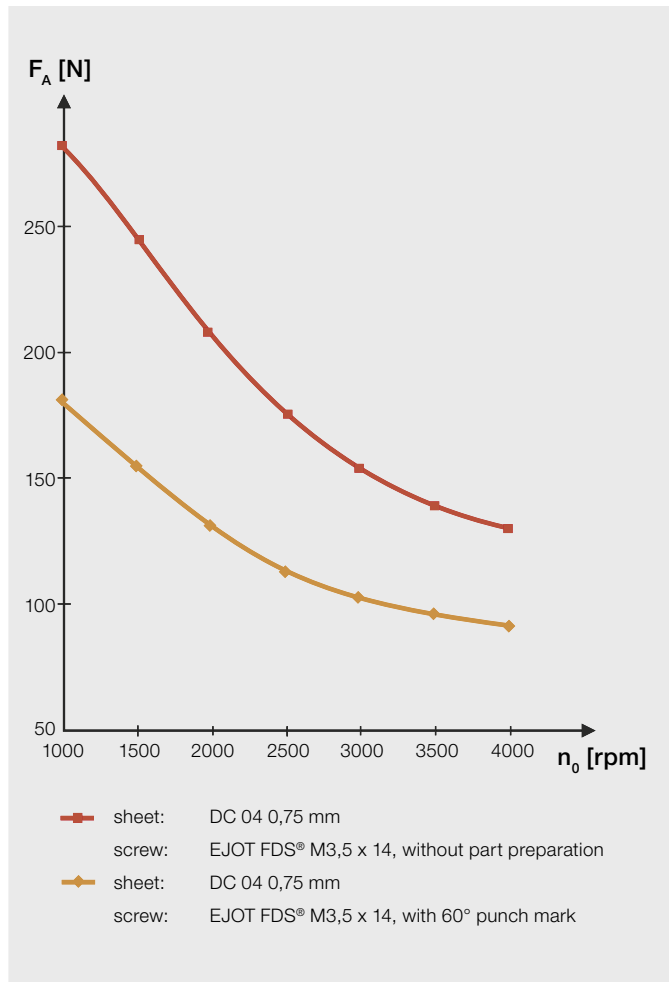

**Driver Tool Selection**

For the flowdrilling process a certain end load and a high driver speed are necessary as well as a certain driver torque for thread forming and tightening. This combination of high speed and torque requires powerful driver tools, which have been developed in cooperation with several tool manufacturers.

Generally all well-known manufacturers of manually and automatically operating driver tools are offering corresponding devices in their programmes. Driver tools should basically be used with a speed of 2000 to 5000 rpm.

The necessary assembly data like driver speed and tightening torque are depending on

- sheet thickness
- material strength
- surface treatment
- material of the clamped part
- requirements of the screw joint.

For manual assembly pneumatic screw drivers with adjustable shut-off clutch are most common.

For fully automated assembly both pneumatic and electric spindels (brushless DC or AC motor) are suitable.

To check the influence of these parameters, often an assembly test is recommended, which could be carried out in the laboratory EJOT APPLITEC.



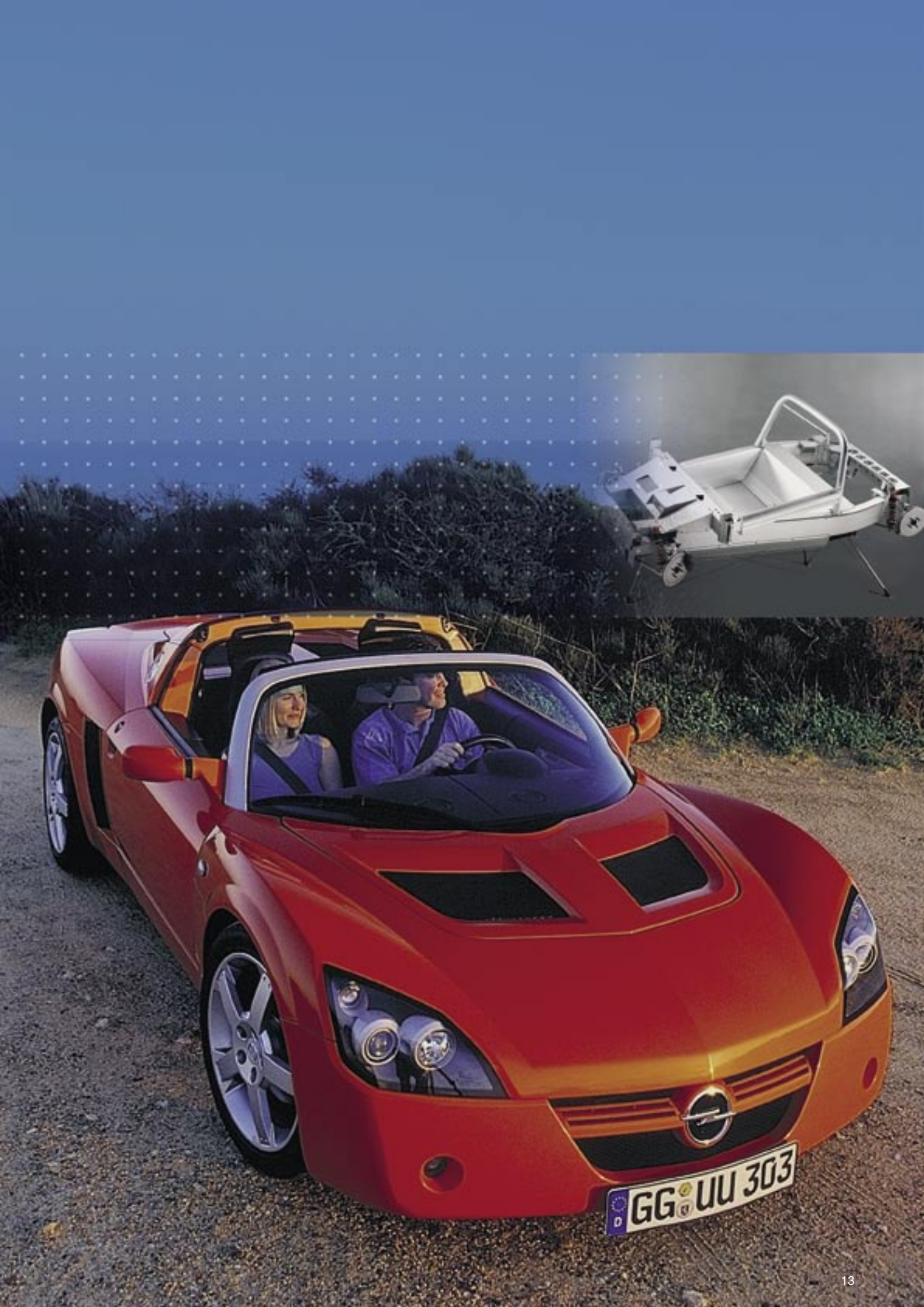

In comparison with mechanical joining methods and spot welding the University at Paderborn (Germany), has tested the FDS® assembly regarding peeling and shearing strength.

Shown are the results of the FDS® joining, the mechanical methods of clinch joining and self piercing riveting and spot welding.

Beside the two diagrams an additional figure shows the strengthness of an FDS® joint with adhesive bonding (Hybrid).

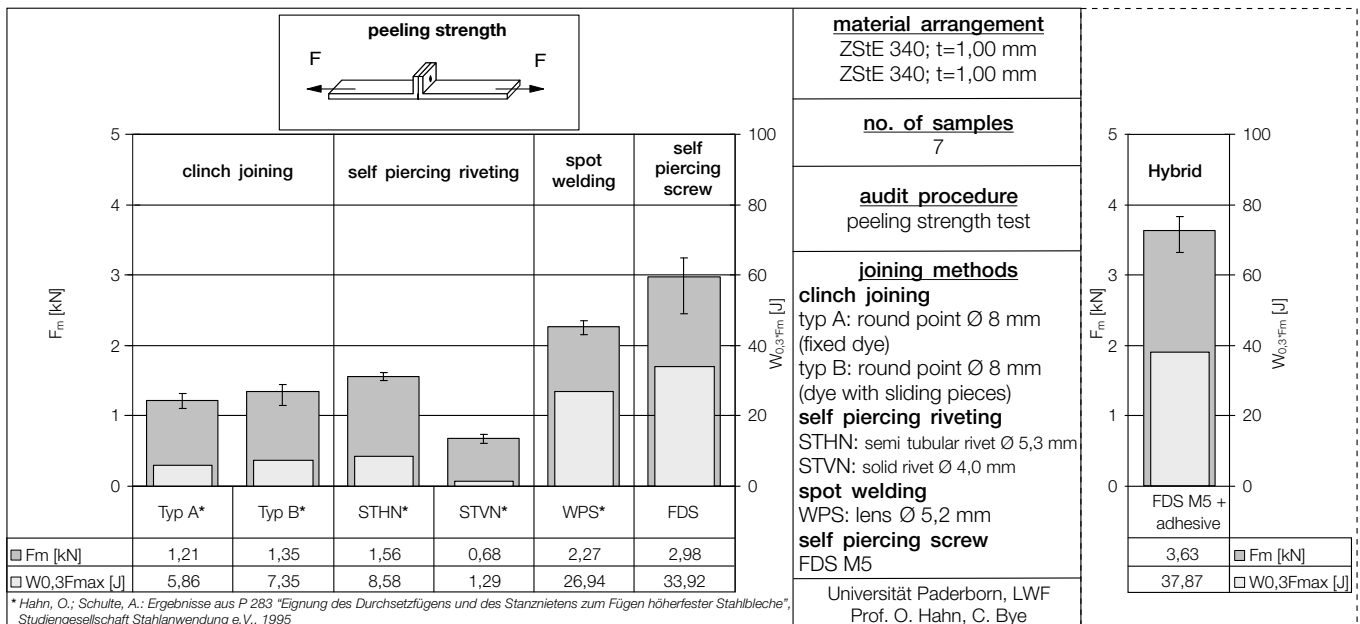

peeling strength  $F_m$  and energy absorption  $W_{0,3Fm}$  of different joining methods in steel (ZStE 340)

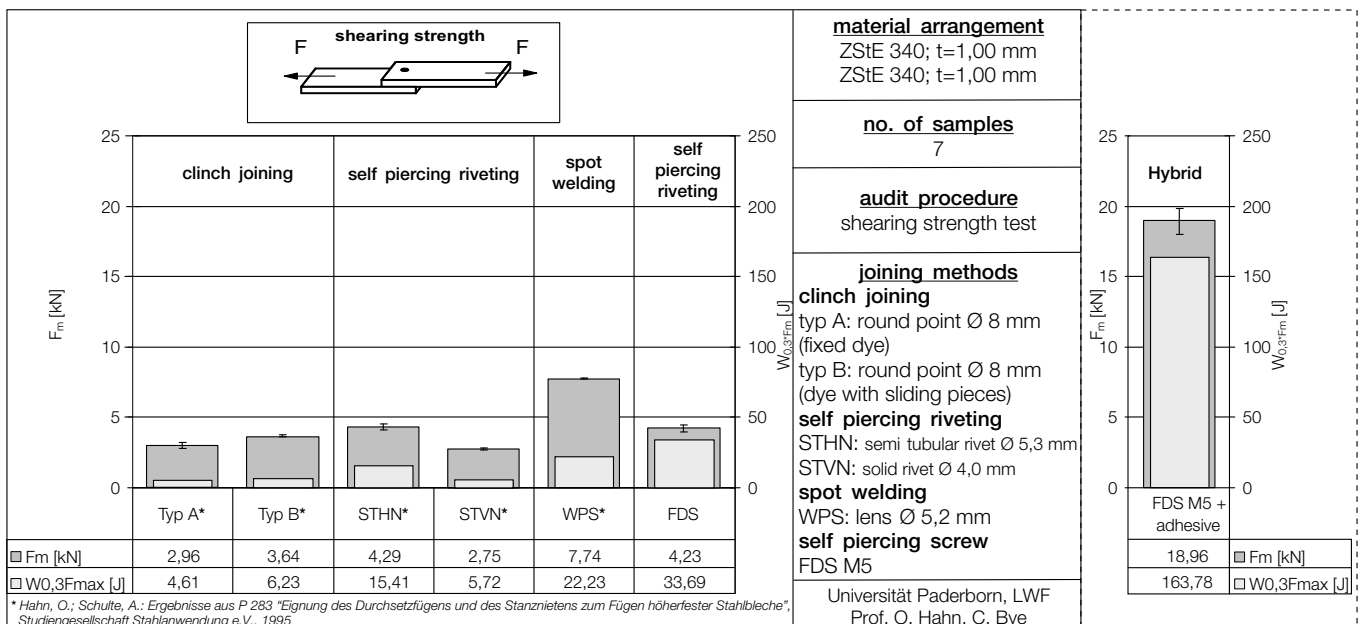

shearing strength  $F_m$  and energy absorption  $W_{0,3Fm}$  of different joining methods in steel (ZStE 340)



To be able to take full advantage of the high-strength steels' material properties, it is necessary to choose suitable joining methods.

Spot welded samples, e.g. of dual-phase steel DP-K30/50 and soft unalloyed steel DC 04, show a 2 up to 3 times higher fatigue behaviour under cyclic load.

When choosing the joining method of EJOT FDS<sup>®</sup>, the fatigue behaviour of component samples of dual-phase steel is strongly improved by factor 10 again, compared to the soft unalloyed steel.

## Dynamic strength of EJOT FDS<sup>®</sup> joints

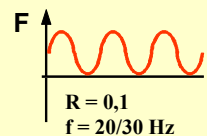
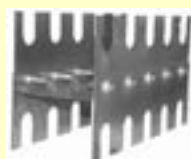
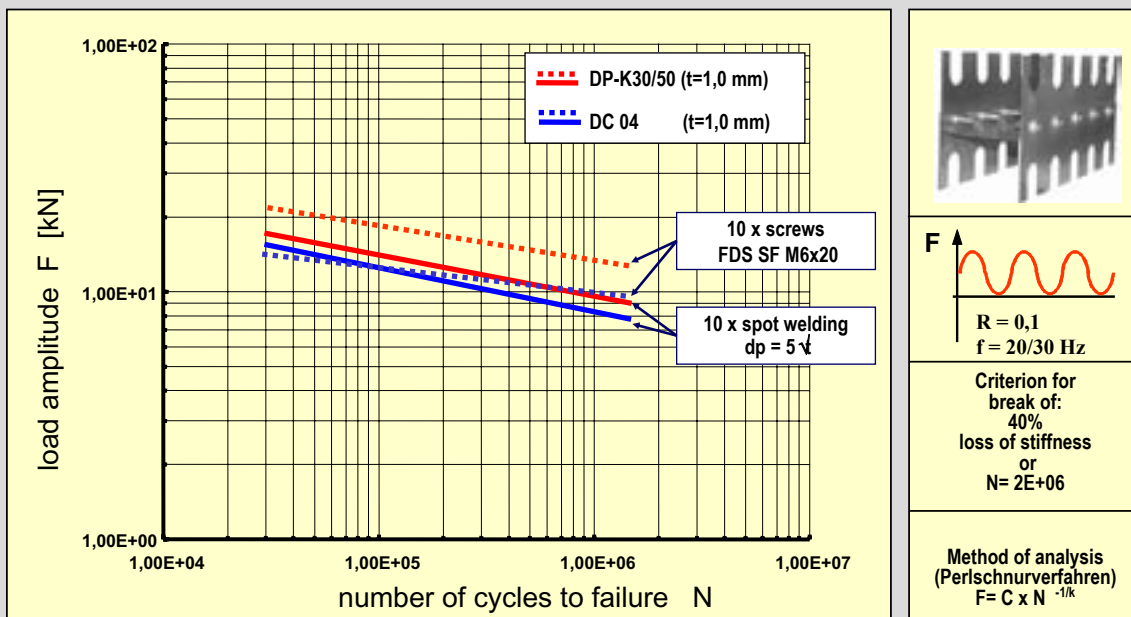

Criterion for break of:  
40%  
loss of stiffness  
or  
 $N = 2E+06$

Method of analysis  
(Perlschnurverfahren)  
 $F = C \times N^{-1/k}$





Types of the basic element (examples)

**Example:  
EJOT FLLASH®**

**The innovative fastening system not only for tube and fluid lines.**

EJOT FLLASH® is a combination of a thermoplastic clip and an integrated EJOT FDS® screw. The system for a safe, chipless and tolerance independent assembly. Expensive prepunching or stud welding can be omitted.

**Benefits:**

- no prepunching or weld stud assembly required
- process-safe and chipless assembly
- free positioning, i.e. independency of tolerances
- captive- pre-assembly screw
- self-locking and sealing screw joint
- easy to assembly / disassemble
- suitable for automated assemblies
- low overall assembly costs
- simple integration by applying modular basic elements or application-specific solutions

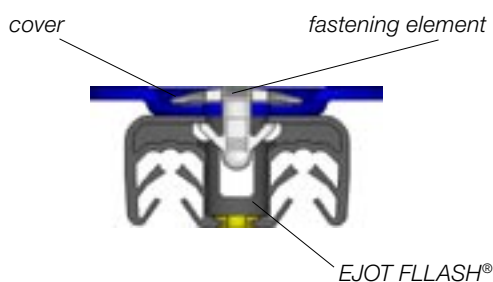
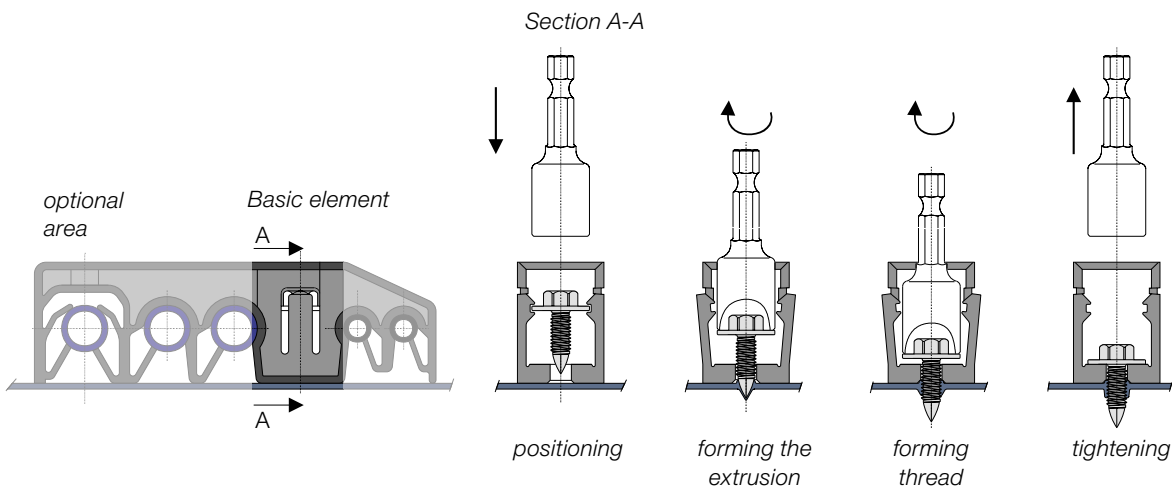

In addition to actual automotive projects many other applications in different industries are possible. Different types of the EJOT FLLASH® can be designed according to customer demands. The EJOT FLLASH® concept allows a captive integration of the screw.

In addition to the FLLASH® product group, EJOT has developed a fastening system which allows to fasten additional elements, like covers and other components.





**Your system partner**

*Test rack at APPLITEC*



*Internal seminar*

**Design Consultation**

A major consideration of today's product manufacture is the basic need to be cost competitive. Significant in achieving this objective is the design process. No other part of the cost structure is influenced more than by design.

Generally speaking, the development of a product, which represents about 10% of the overall costs, determines about 70% of the costs for the final product.

Often the design of the fixing is considered to be of low importance; however, it is the fastener that holds the components together to make the finished product. With this in mind the design engineer should consider which fastening method to use during the design conception stage to avoid expensive design changes late on in the design process or even when the product goes into production.

To assist our customers in this process EJOT offers support during the design stage through comprehensive application engineering services. These services provide accurate information on product performance and result in design recommendations that can be used safely on the production line.

**Application Engineering Consequent**

By continuously working with our customers and their application problems, EJOT has amassed a comprehensive understanding of fastener technique that has lead to a number significant of innovations. It is our goal to continually improve our products to meet the ever increasing demands of our customers.

In addition to our highly qualified Engineers and application-engineering advisers, we offer the service of our application laboratory known as the EJOT APPLITEC. In the APPLITEC we carry out test procedures on our customer's applications that enables us to thoroughly analyse the strength and capability of their parts. It is here that new fastening techniques are also developed.

The knowledge EJOT has gained over the years is passed on to our customers finding the most effective solution supporting their efforts in establishing rational fastening and assembly techniques. Detailed test reports, on site technical advice, acknowledged seminars and technical publications demonstrate our continued commitment to impart our knowledge.



*Test report*

**Logistic and Data Exchange**

It is our aim to keep procurement and warehousing costs as low as possible by simultaneously offering product availability and quality.

With respect to simplified procuring processes, EJOT offers a variety of cost reducing procedures and services. The continued analysis of our customer's demands and advanced logistics procedures are leading to high availability of our products. Skeleton contracts and delivery schedules via electronic data interchange facilitate and accelerate the processing times of our products.

**Quality for Automated Assembly**

Successful automated assembly means high availability of the assembly machine. A significant impact on this can be expected from the fasteners grade of purity. Historically, the standard quality in commercial fastener manufacture is not sufficient for today's high quality requirements since originally it has been designed for mainly manual assembly.

EJOT introduced the EJOMAT® Quality to ensure the most costly effective usage of our customer's automated assembly machines.

The grade of purity offered by EJOMAT® quality is 10 times higher than the usual standard quality which means increased availability of assembly machine and decreased assembly down time costs.

EJOMAT®, quality that pays for itself.

**EJOT Sales Organization**

In addition to EJOT companies throughout Europe a growing number of Licensees in North & South America and Asia ensures that product availability and local support is Global.

Contact details can be found on our Homepage [www.ejot.de](http://www.ejot.de).



*Modern PPS-systems lead to high accuracy in supplying and short through put times*



*EJOMAT® for fully automated assembly*



**EJOT GmbH & Co. KG**

Industrial Fasteners Division

Untere Bienhecke

D-57334 Bad Laasphe

P.O. Box 1163

D-57323 Bad Laasphe

phone +49 2752 109-0

fax +49 2752 109-141

e-mail: [industrie@ejot.de](mailto:industrie@ejot.de)

Internet: [www.ejot.com](http://www.ejot.com)